

PEEK is used in Textile Printing and Dyeing Machinery Industry



JiangSu JunHua HPP Co., Ltd.



BUSINESS PHILOSOPHY

经营理念

诚信·务实·合作·创新·共赢

CONTENTS

- 01 - 02 Company Profile
- 03 - 04 Enterprise Honor
- 05 - 06 Development History
- 07 - 08 PEEK High Performance Special Engineering Plastics
 - 09 PEEK Main Grades and Performance Indicators
- 10 - 11 PEEK Characteristic Advantages
- 12 - 18 PEEK is used in Textile Printing and Dyeing Machinery Industry
 - 19 Process Capability
 - 20 Testing Equipment

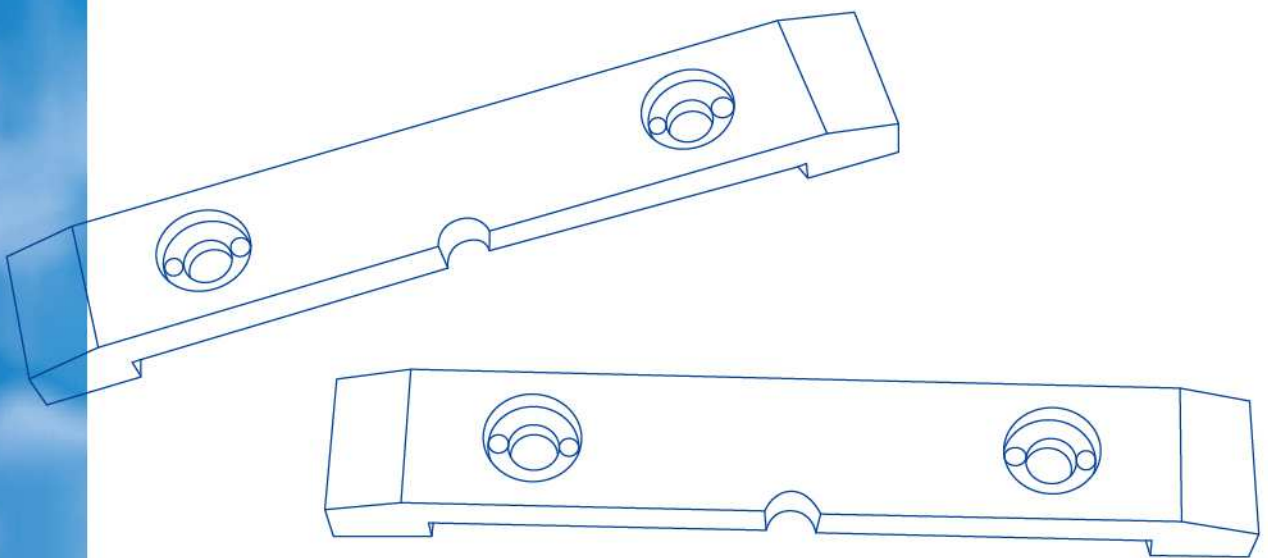

COMPANY PROFILE



8000+

Industry Elite Customers

Jiangsu Junhua Special Polymer Materials Co., Ltd. focuses on the application, development and production of PEEK (polyether ether ketone), PI (polyimide) and other high-performance special engineering plastic resins and profiles, and has formed a whole industry chain with PEEK resin raw material polymerization, modified granulation, plate and bar segments and other profiles continuous extrusion molding and finished parts injection molding and machining.

15000+

Square Meters of
Standardized Plant

PEEK, PI and other high-performance plastic parts produced by our company have been widely used in textile printing and dyeing machinery, food processing, packaging and beverage filling, aerospace, special equipment, new energy vehicles, electronic semiconductors, medical equipment, petrochemical machinery and other fields.

20000+

PEEK Product Application Cases

Junhua shares warmly look forward to exchanges and cooperation with special engineering plastics research and use units, jointly promote the application of special engineering plastic parts such as PEEK and PI in various industries, and achieve product upgrading.

Welcome to our company for guidance and exchange!



>>> Process Capability

- ◇ The formulation design and composite modification of special polymer materials such as PEEK and PI ;
- ◇ Making drawings, 3-D drawings according to products;
- ◇ Cooperate with customers to carry out the application development and production of new products of special polymer materials ;
- ◇ There are nearly two thousand kinds of injection molding molds for PEEK and PI parts in various industries ;
- ◇ Continuous extrusion production of PEEK plate, rod, tube and sheet ;
- ◇ Provide testing services for hardness, mechanical properties, friction and wear performance indicators.

>>> Advantages

 <p>59 Patent Continuous Technology Innovation</p>	 <p>PEEK Industry Chain Material polymerization-profile extrusion-finished parts</p>	<p>ISO9001 Quality Assurance System IATF16949 Quality Management System AS9100D Aerospace System</p>
<p>YEARS 18 18 Years PEEK application, R&D and production experience</p>	<p>1250mm Ten million grade imported extrusion equipment for super large size</p>	 <p>15000m² Standardized production plant</p>

ENTERPRISE HONOR

>>> R&D Platforms & Patents

< Preparation of phenol-terminated polyaryletherketone polymers>

<a continuous CF/PEEK thermoplastic composite material and its production method>

26 patents for inventions and 33 patents for utility models.



Jiangsu Industrial Design Centre

We can help customers to optimize the design of the structure, function and appearance of PEEK parts. With rich experience in the design and manufacture of PEEK precision moulds, adopt advanced processes such as hot runner to significantly reduce costs.



Jiangsu Enterprise Technology Centre

With the advantages of the platform, the layout of the 'industrial chain + innovation chain, solve the key technical problems, attract scientific talent, improve the R & D management system, improve the rate of conversion of results, to become a high-quality enterprises in the PEEK industry to master the core technology.

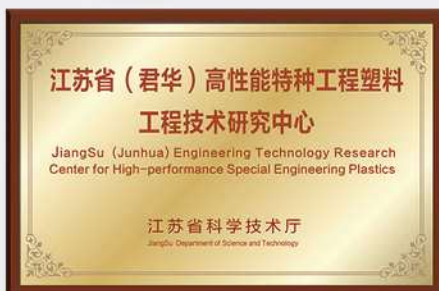

Jiangsu Engineering and Technology Research Centre

Positioned around the PEEK and other high-performance special engineering plastics industry needs, to promote scientific and technological innovation as the goal, to strengthen the engineering R & D platform construction.

>>> System Certification

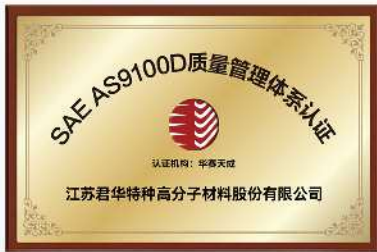

Company through ISO9001, IATF16949 certification, ISO13485 certification, AS9100D aerospace quality system certification, FDA food grade certification, RoHS testing and other third-party certification.

>>> Qualification Certificate



DEVELOPMENT HISTORY

Continuous CF/PEEK thermoplastic composites and medical-grade AKSOPEEK® have passed the new product verification by Industry And Information Technology Department of Jiangsu.
Completed equity incentives and corporate shareholding reform.
Initiate the standardization of internal control system for IPO.
Initiate the design and construction of a new smart factory.

Establish "Changzhou Industrial Design Center" and "Provincial Engineering Technology Research Center".
The "Jiangsu Province Double Entrepreneurship Project" was successfully declared.
Pass the AS9100D aerospace system certification.
Win the title of "Changzhou Specialty, Specialty and New enterprise" and "2021 Material SAMPE China Innovation Finalist Award".

Establish Shandong Junhao High Performance Polymer Co., Ltd. and started the PEEK resin polymerization industrial plant;
Establish the medical industry division;
Establish the CF/PEEK composite materials division
Passed the IATF16949 quality management system certification;
Establish Changzhou High Performance Special Engineering Plastic Engineering Technology Research Center;
Pass biocompatibility testing and certification.

Passes the national high-tech enterprise certification;
Start the PEEK polymerization pilot plant and put it into production at the end of the year.

Increase capital to 10 million and changed its name to Jiangsu Junhua Specialty Plastics; PEEK profiles passes RoHS, FDA Certification; the company has passed the certification of provincial private technology enterprises.

We enacted the first PEEK manufacturer standard in China and pass the record.

2007

Changzhou Junhua High Performance Speciality Engineering Plastic(PEEK) Co, Ltd. Founded and located at Jiangsu Yangtze River Delta Mould City.

2012

2014

2015

2016

2018

2019

2020



2024

Junhua shares Changzhou intelligent new factory began to lay the foundation.
Junhua Shares won the second prize of Jiangsu Science and Technology Award.

2023

Changzhou Junhua Medical entered Gongyanhui and opened a new factory.
Won the titles of national specialized and new "Little Giant" Enterprise, "Jiangsu Provincial Enterprise Technology Center", "Jiangsu Industrial Design Center" and so on.

2022

The company's medical PEEK material preparation key technology-PEEK medical catheter R&D and industrial project (Changzhou Key R&D Program in 2020-Industrial Technology Support Program) received government funding support.
PEEK5600CF30 and CF/PEEK composite materials have passes the ISO10993 biocompatibility test.
The PEEK composite material developed by Junhua chinaPEEK has realized the high-reliability zero-locking performance of the booster servo mechanism, and contributed its own meager strength to the successful launch of the Long March 5B rocket.

2021

Establish Shandong Junhao High Performance Polymer Co., Ltd. and started the PEEK resin polymerization industrial plant;
Establish the medical industry division;
Establish the CF/PEEK composite materials division
Passed the IATF16949 quality management system certification;
Establish Changzhou High Performance Special Engineering Plastic Engineering Technology Research Center;
Pass biocompatibility testing and certification.







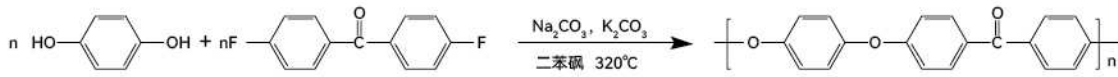

Pass ISO9001 quality management system certification.

PEEK and Property

PEEK (polyether ether ketone) resin is a special thermoplastic material with high performance, and is one of the most important varieties of commercial polyether ether ketone resins. At present, PEEK has excellent high temperature resistance, wear resistance, self-lubrication, low noise, corrosion resistance, high strength and other comprehensive properties, is widely used in textile printing and dyeing machinery, food processing, packaging and beverage filling, automotive and aerospace and other fields.



【 PEEK shows excellent overall performance due to its large amount of benzene ring structure in its molecule 】

 <p>Lightweight Compared with metal, the use of energy consumption is significantly reduced</p>	 <p>High Temperature Resistance melting point 343°C, long-term use temperature of 260 °C, short-term use temperature up to 300°C.</p>	 <p>Wear-resistant PEEK and its composite material have good wear-resistant properties, which is three times than that of copper alloy.</p>	 <p>Hydrolysis Resistance low hygroscopicity, can work in water and steam for a long time.</p>
 <p>Corrosion Resistance resistant to acids and alkalis and other solvents, high temperature halogen and strong acid corrosion, etc., at room temperature dissolved in concentrated sulfuric acid.</p>	 <p>Self-lubricating it can work stably for a long time without oil, and the appearance of the equipment is more neat and clean.</p>	 <p>Convenient Moulding PEEK has good processing and moulding characteristics, according to the customer's drawings or samples can be easily processed using a variety of processes or a variety of complex shaped parts.</p>	 <p>Dimensional Stability low coefficient of expansion, which radically reduces the risk of swelling.</p>

>>> Plastic Classification

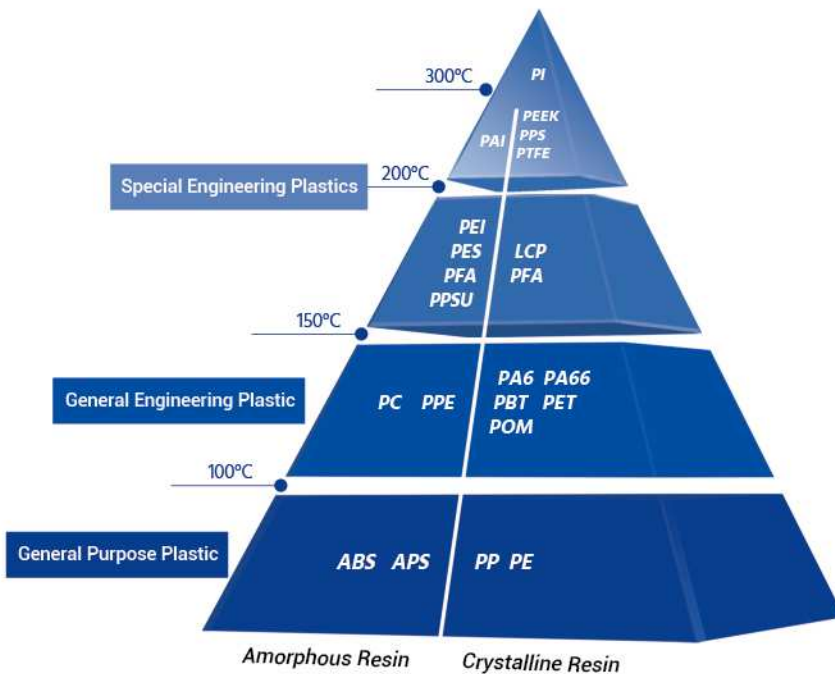



Width Thickness
 600~1250 — 5~100 mm Please contact us for the specification list!

Continuous extrusion of PEEK sheet

Compared with the traditional molding process, its uniformity and production efficiency are significantly improved. And according to customer needs to develop U-shaped, Z-shaped and other special-shaped profiles.

The introduction of 1250mm wide PEEK plate extrusion production line imported from Europe has greatly improved the company's production capacity while improving the quality of the plate, effectively ensuring the customer's requirements for product delivery.

Continuous extrusion of PEEK rod

Excellent machining performance, can replaced product of large size, high thickness and small batch that can't be finished by injection molding.

PEEK rods diameter 1-300mm can be produced by extrusion. The general length is 1000 or 3000mm, length also customized, hundreds of mold existed to meet customer requirement, stock available all the year round.

Diameter Length
 1~300 — 1000~3000 mm Please contact us for the specification list!



Continuous extrusion PEEK pipe

A new solution for lightweight pipework that meets the aerospace industry's stringent requirements for safety, quality and performance.

Lighter than comparable metal tubes used for low-pressure liquid transport.

Can be bent, molded and adapted for flaring and reinforcement.

Please contact us for the specification list!

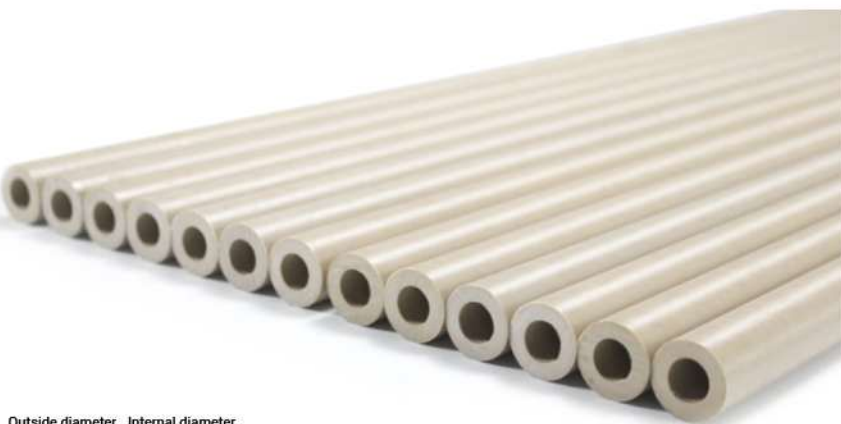

Outside diameter Internal diameter
 1~597 — 1~450 mm

PEEK Main Material Grade and Typical Properties

>>> Mechanical Behavior

Item	Test Standard or Instrument	Unit	PEEK5600G	PEEK5600GF30	PEEK5600CF30	PEEK5600LF30	PEEK5600FE20
			100%PEEK	PEEK+30% glass fiber	PEEK+30% carbon fiber	PEEK+30%(carbon fiber+graphite+PTFE)	PEEK+20%PTFE
Tensile Strength (23°C)	ISO 527	MPa	95	175	250	145	70
Tensile Modulus (23°C)	ISO 527	GPa	3.8	11	23	12.5	/
Elongation at Break (23°C)	ISO 527	%	35	2.0	1.5	2.2	/
Bending Strength (23°C)	ISO 178	MPa	155	235	350	220	118
Bending Modulus (23°C)	ISO 178	GPa	3.5	10	21	11	/
Charpy Impact Strength (No Gap)	ISO 179/1U	kJ/m²	No break	55	45	32	No break
IZOD Impact Strength (Gap)	ISO 180/A	kJ/m²	4	6	6.5	4	6

>>> Thermal Performance

Melting Point	ISO11357	°C	343	343	343	343	343
Distortion Temperature	ISO 11357	°C	143	143	143	143	143
Continuous Using Temperature	ISO 75A-f	1.8MPa, °C	152	315	315	293	150
Coefficient of Thermal Expansion	ASTM D696	ppm K-1	45	22	15	22	70
Thermal Conductivity	ISO /CD22007-4	W/ (m·K)	0.29	0.32	0.95	0.86	/

>>> Electrical Performance

Dielectric Strength (2mm)	IEC 60243-1	kV/mm	20	19	/	/	19
Dielectric Constant	IEC 62631	-	3.0	3.3	/	/	2.7
Surface Resistivity	GB/T31838.3	Ω	10 ¹⁵	10 ¹⁴	/	/	10 ¹⁵
Volume Resistivity	IEC 62631	Ω·cm	10 ¹⁵	10 ¹⁵	10 ⁶	10 ⁶	/

>>> Other Performance

Colour	-	-	Natural	Natural	Black	Black	Natural
Melt Flow Rate (400°C, 2.16kg)	ISO 1133	g/10min	6-10	2-5	1-3	2-5	/
Density	ISO 1183	g/cm3	1.30±0.02	1.50±0.02	1.40±0.02	1.44±0.02	1.41±0.02
Water Absorption (23°C, 24Hrs)	ISO 62-1	%	0.07	0.05	0.04	0.05	0.15
Mould Shrinking Percentage	Parallel to the flow direction	%	1.2	0.4	0.1	0.3	1.3
Mould Shrinking Percentage	Perpendicular to the direction of flow	%	1.5	0.8	0.5	0.6	1.8
Rockwell Hardness	GB/T 3398.2	HRR	118	119	121	108	113
Flammability Rating	UL 94	/	V-0	V-0	V-0	V-0	/
Friction Coefficient	ASTM D3702	100N-120rpm	0.30-0.38	0.38-0.46	0.15-0.25	0.18-0.30	0.1-0.2

★ This parameter represents a value, not a guaranteed value. If you need to call me division technology department for more detailed technical indicators!

Brand Number	PEEK5600G	PEEK5600CF30	PEEK5600GF30	PEEK5600LF30
PEEK Resin				
Brand Number	PEEK5600FE20	PEEK5600SWR	PEEK5600CF30-GQ	JUNHUA-HT4600CF30
PEEK Resin				

PEEK Main Feature Advantages

>>> Corrosion Resistance

PEEK maintains excellent resistance to various chemicals over a wide temperature range, maintains excellent mechanical properties, rarely fades or expands under normal circumstances, and has excellent chemical resistance. At the same time, the water absorption rate of PEEK is very small, and the saturated water absorption rate of 23°C is only 0.5%. Moreover, PEEK has good heat resistance and can be used in pressurized hot water or steam at 300°C.

Unfilled PEEK strips were immersed in chemical reagents at constant temperature for at least 7 days (concentrated, unless otherwise stated). Chemical compatibility was assessed by preserving mechanical properties, supplemented by weight or dimensional changes. Compatibility is classified as A, B or C, as explained below;

A - does not work. Materials can be used in applications exposed to these agents. However, it is still recommended that the actual application needs to be verified.

B - Slight effect. Materials can be used in certain situations where they are exposed to these agents. It is necessary to evaluate the performance criteria applied in these specific applications.

C - Serious effect. Materials are considered to be permitted to come into contact with such chemicals under certain circumstances.

ACIDS	酸类	23°C	100°C	200°C
Hydrochloric Acid, Conc.	浓盐酸	A	B	
Aqua regia	王水	C	C	C
Carbonic Acid	碳酸	A	A	
Chromic Acid, 40% Conc.	40%铬酸溶液	A		
Chromic Acid, Conc.	浓铬酸	C	C	C
Citric Acid	柠檬酸	A	A	
Nitric Acid, 10% Conc.	10%硝酸溶液	A	A	
Nitric Acid, Conc.	浓硝酸	C	C	C
Nitrous Acid, 10% Conc.	10%亚硝酸溶液	A		
Sulfuric Acid, >40% Conc.	>40%硫酸溶液	C	C	C
Oxalic Acid.	草酸	A	A	
ALCOHOLS	醇类	23°C	100°C	200°C
Butanol	丁醇	A		
Ethanol	乙醇; 酒精	A	A	A
Glycerol	甘油; 丙三醇	A		
Methanol	甲醇	A	A	
BASES	碱, 金属氢氧化物	23°C	100°C	200°C
Ammonia 880	饱和浓氨水	A		
Ammonia liquid	液氨	A	A	A
Ammonium Hydroxide, 10% Conc.	10%氢氧化铵溶液	A		
Calcium Hydroxide	氢氧化钙	A		
Potassium Hydroxide, 10% Conc.	10%氢氧化钾溶液	A		
Sodium Hydroxide, Conc.	浓度氢氧化钠	A		

>>> Biocompatibility Test

Experimental Standards	Experiment Titles	Test Samples	Experiment Results
ISO10993-4	In vitro hemolytic properties test	PEEK5600G	✓
ISO10993-5	In vitro cytotoxicity test	PEEK5600G	✓
ISO10993-10	Intracutaneous reactivity test	PEEK5600G	✓
ISO10993-10	Skin sensitization test	PEEK5600G	✓
ISO10993-11	Acute systemic toxicity test	PEEK5600G	✓
ISO10993-11	Pyrogen test	PEEK5600G	✓



>>> Wear Resistance

Low coefficient of friction and outstanding wear resistance, better performance than metal in many harsh environments, no worry of rust and metal shavings.

Test Conditions: [Loading Force:300N(2.39MPa) Rotation Speed:120rpm(0.17m/s) Wear Part:316L Test Method:Dry Grinding] -Room Temperature Test				
Brand Number	Pre-Test Weight /g	Post-Test Weight /g	Friction Time /h	Wear Extent mg/h
PEEK5600G	2.347	2.313	24	1.42
PEEK5600GF30	2.452	2.385	24	2.8
PEEK5600CF30	2.425	2.413	24	0.5
PEEK5600LF30	2.634	2.603	24	1.29
PEEK5600FE20	2.562	2.559	24	0.13
PPS	2.484	2.475	1	9
PPSU	2.299	2.266	0.07(4min)	495

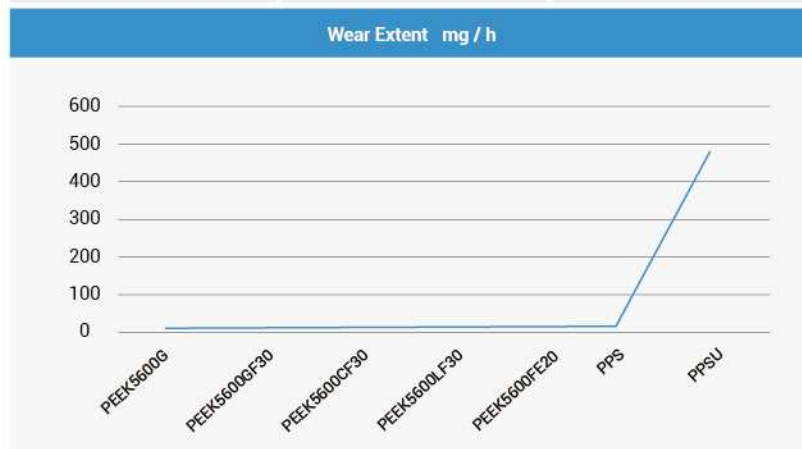

>>> High Strength

Compared with POM, PEEK5600G(pure PEEK) with higher strength and toughness.

This is mainly based on the main chain of the molecule of PEEK at the same time with toughness group - ether bond and rigid group - benzene ring, is a strong and tough materials. And its fibre reinforced, the strength greatly increased, such as PEEK5600CF30, the tensile strength of 230Mpa, is twice of the pure PEEK.

Aterial Type	Tensile MPa	Notched Impact Strength
PEEK5600G	103 MPa	9.5 kJ/m ²
PEEK5600GF30	170 MPa	9 kJ/m ²
PEEK5600CF30	230 MPa	9 kJ/m ²
POM	64 MPa	6 kJ/m ²

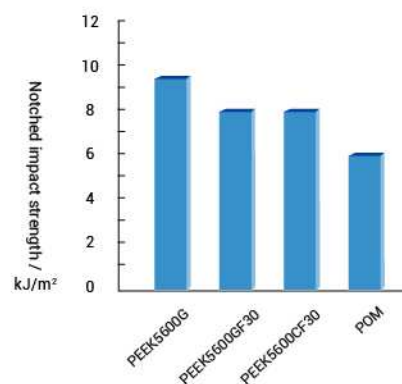
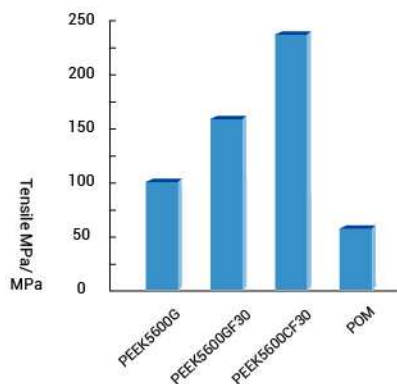

A person wearing a blue long-sleeved shirt is operating a textile printing machine. The machine has a large, curved metal frame with a grid-like pattern. The person's hands are visible, adjusting a component of the machine. The background is slightly blurred, showing more of the industrial setting.

PEEK is used in Textile Printing and Dyeing Machinery Industry

PEEK is a kind of high-performance engineering plastic, with high temperature resistance (long-term tolerance 260°C, short-term tolerance 300°C high temperature), corrosion resistance, hydrolysis resistance, self-lubrication, wear resistance, high strength, high precision, dimensional stability and other characteristics. In the printing and dyeing machinery industry is widely used in the manufacture of high load, high temperature, high-speed working conditions of mechanical parts, PEEK application can reduce equipment failure and downtime, improve production efficiency and product quality.

>>> PEEK Amplitude Adjusting Nut

In the textile printing and dyeing enterprises, during the process of tentering and shaping, the guide position need to be adjusted by different amplitude. Traditional copper alloy nut is easy to bite with the metal screw and make damage, usually need to fill the grease, spray molybdenum disulphide lubricants, which not only increases the maintenance costs of the setting machine and also pollute the fabrics. It has become a major problem, a nut no need of grease is necessary need to replace the copper ones.

Our PEEK amplitude adjustment nut, by injection moulding and machining process, has the advantages of high temperature resistance, corrosion resistance, self-lubrication, abrasion resistance, maintenance-free, long service life, etc., can reduce the wear of metal screw, and prolonging the service life for its self-lubricating properties(three times of that of copper ones) .the maintenance cost largely reduce for no need of grease and molybdenum disulphide, avoid fabric pollution and ensure the fabric quality.

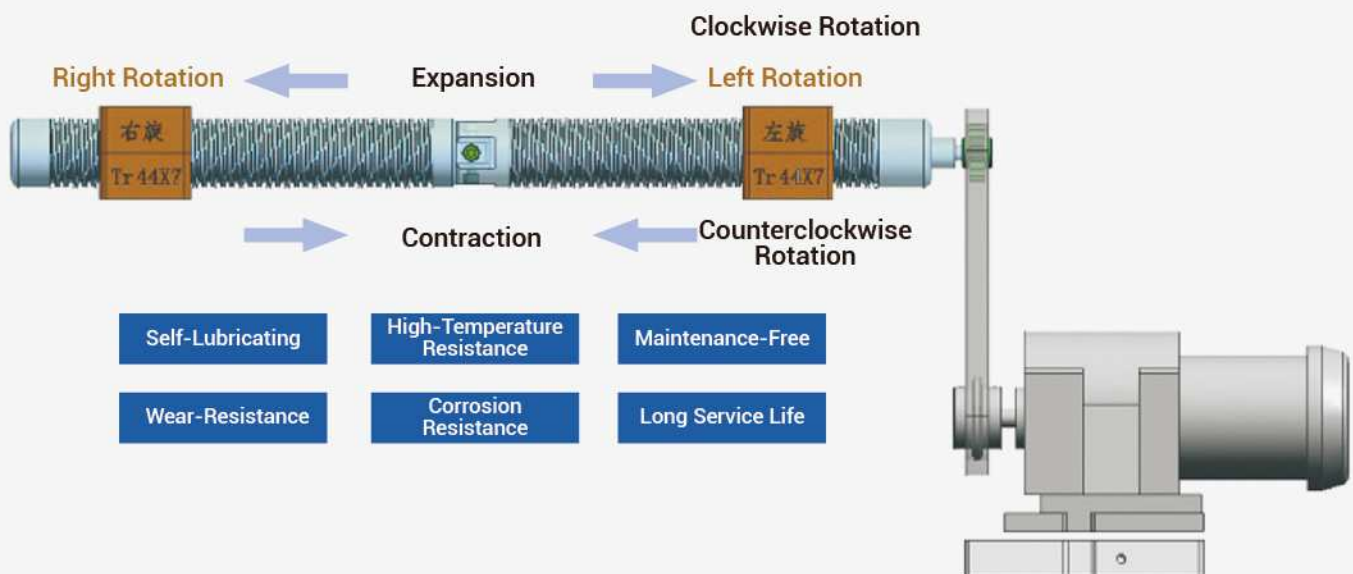

>>> PEEK Amplitude Adjusting Nut Other Products on Display



▲ PEEK Amplitude Adjusting Nut



▲ Huangji PEEK Amplitude Adjusting Nut



▲ PEEK Rectangular Amplitude Adjusting Nut



▲ PEEK Cylindrical Amplitude Adjusting Nut



▲ PEEK Cylindrical Amplitude Adjusting Nut



▲ PEEK Amplitude Adjusting Nut (with iron frame)



▲ BRUCKNER Amplitude Adjusting Nut



▲ LK Amplitude Adjusting Nut



▲ CHENG FU Amplitude Adjusting Nut

>>> PEEK Inner Sleeve

PEEK inner sleeve can be used for various sliding components in textile machinery, such as the sizing roller in a stenter machine, the printing roller in a printing machine, the combing roller in a cotton combing machine, and so on.



▲ PEEK Bushings



▲ PEEK Guide Groove Bushings



▲ PAI Bushings



▲ PEEK Top Stack Sleeve



▲ Monfuji PEEK Inner Sleeve



▲ Wear-resistant Sleeve of Oxygen Bleaching Machine

>>> PEEK Protective Covers

PEEK protective covers can be used in various parts of textile machinery, such as setting machines, printing machines, and heat transfer machines. In setting machines, PEEK protective covers can be used to manufacture protective covers and slide block covers, among other components, to improve the machine's wear resistance and stability. In printing machines, PEEK protective covers can be used to manufacture covers for the mechanical hands and slide blocks, among other components, to ensure the safety and stability of the machine during high-speed operation. In heat transfer machines, PEEK protective covers can be used to manufacture protective covers for the transfer head, among other components, to ensure the safety and stability of the machine.



>>> PEEK Valve Stem

PEEK valve stem can be used in various valves and piping systems in the textile printing and dyeing machinery, such as feeding pipes, discharge pipes, wastewater treatment systems, circulation water systems, etc.



>>> Other Products on Display



▲ PEEK Buffer Wear Strips



▲ PEEK Track Wear Strips



▲ PEEK Lifting Wear Strips



▲ PEEK Dust Cover



▲ PEEK Self-lubricating Wear-resistant Gear



▲ Flat Edge Spreader
Wear-resistant Helical Plate

>>> PEEK Hexagonal Sleeves



The comprehensive frame, an essential component in the textile printing and dyeing industry, consists of upper and lower crossbeams, side brackets, rapier rods, and driving components. It facilitates the weaving process by collecting warp yarns and creating patterns as the rapier moves up and down.

To ensure connection and wear resistance in the comprehensive frame, PEEK hexagonal shaft sleeves are used. Unlike traditional graphite sleeves that are brittle and prone to wear and fracture in high-speed environments, our company has developed hexagonal shaft sleeves using our proprietary PEEK material. These sleeves are lightweight, have low noise, offer high wear resistance, self-lubrication, and a long lifespan.

Our PEEK hexagonal shaft sleeves provide a cost-effective alternative, reducing consumables replacement costs and delivering superior impact resistance and wear performance in weaving machines.

Application

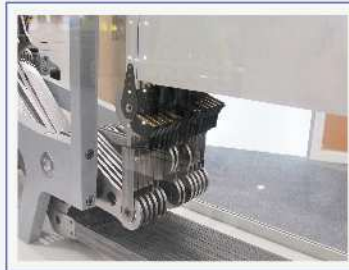

Dimensions

Dia. 22mm	Dia. 23mm
Dia. 25mm	Dia. 25.3mm



>>> PEEK Wear-resistant Slide Block

PEEK wear-resistant slide block can be used in various moving parts of textile machinery, such as the printing scraper of the printing machine, the combing plate of the cotton combing machine, and the shaping roller of the shaping machine. PEEK material has excellent wear resistance, which can effectively reduce the wear and damage of mechanical parts, thereby improving the service life and performance stability of textile machinery.



▲ ARTOS PEEK Slide Block



▲ SANTEX PEEK Slide Block



▲ BRUCKNER PEEK Slide Block



▲ BRUCKNER Big PEEK Slide Block



▲ KRANTZ PEEK Slide Block



▲ K30 KRANTZ PEEK Slide Block



▲ Wear-resistant Slide Block for Clip



▲ PEEK Size Slide Block



▲ BABCOCK PEEK Slide Block

Process Capability

RAW MATERIAL

01

Self-development PEEK Material

The company's self-developed polymerized PEEK resin raw materials provide differentiated solutions for different downstream needs. This move meets the diversified needs of the industry, significantly reduces customer costs, realizes effective domestic substitution, and enhances market competitiveness.

OPENING MOULD

02

Strong New Product Design Capabilities

The company set up new product development department and PEEK industrial design center to provide customers with PEEK injection molding product structure and mold design. So far, we have completed thousands of PEEK product designs and accumulated rich experience in high-precision and ultra-complex product development.

PLASTIC INJECTION

03

Eighteen Years Experience in Injection Molding

Due to the high injection temperature, poor fluidity and large shrinkage rate, PEEK material is more difficult than ordinary plastics in dimensional accuracy and appearance control. Our company has 18 years of experience in PEEK injection molding, and the mature process ensures that the product size meets customer needs and the order is completed with minimum raw material loss.

>>> Precision Mold Processing Design



Testing Equipment

>>> Product Processing and Quality Control



Cool Jet Dry Ice Deburring Equipment Improve the Quality of Machined Parts

- ▶ Non-destructive cleaning;
- ▶ Improve product quality and reduce scrap rate;
- ▶ No need to manually remove burrs and flashes;
- ▶ No secondary waste;
- ▶ Remove burrs and flashes faster and more evenly.

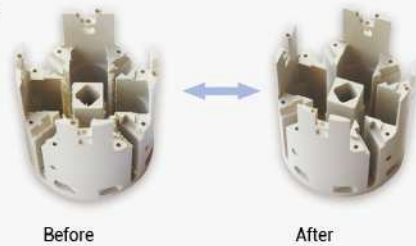

Dry ice cleaning technology is an effective deburring solution for removing burrs and flaps from machined and molded parts. Including small holes, cross holes, pollution-free, can effectively prevent the pipeline flow reduction or blockage caused by burrs, and no residue.

>>> Raw Material Performance Testing Equipment



Universal testing machine is used to test conventional mechanical performance parameters such as product tensile bending strength and modulus.



The impact tester is used for raw material inspection and testing the impact strength.



Hardness tester is used to test the Rockwell hardness of raw materials.



Density detector is used to detect the actual density of the product.



The liquid chromatograph can be used to detect the pressure-tightness and pressure-holding properties of pipe connections such as joints, two-way and three-way connections.

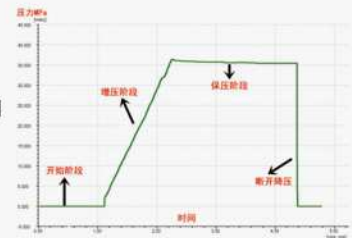

www.junhuaPEEK.com

JiangSu JunHua HPP Co.,Ltd.

Tel: +86-519-86228816 +86-13915088386

Web: www.junhuaPEEK.com

Mail: chinaPEEK@chinaPEEK.com

Add: South Wuyi Road 377#, Creation industrial park, No.11 workshop,
Wujin Hi-tech District, Changzhou, China

International Business Department

Tel: +86-519-86228823

+86-519-86228851

Mail: chinaPEEK@chinaPEEK.com



Official Wechat Account Customer Service Account